

53SS Stainless Steel

Wall Guard

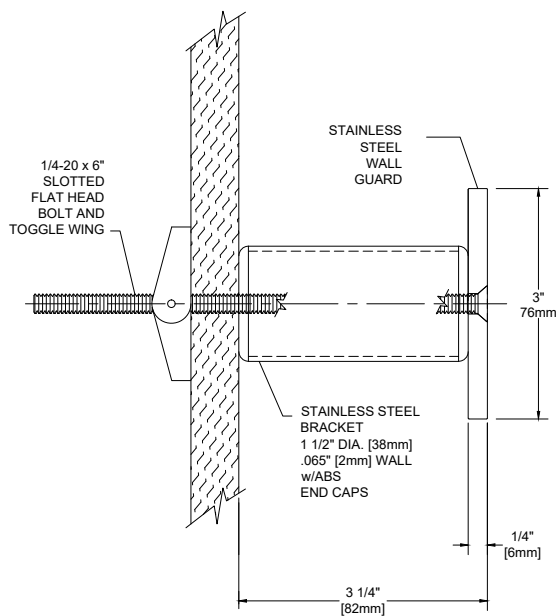
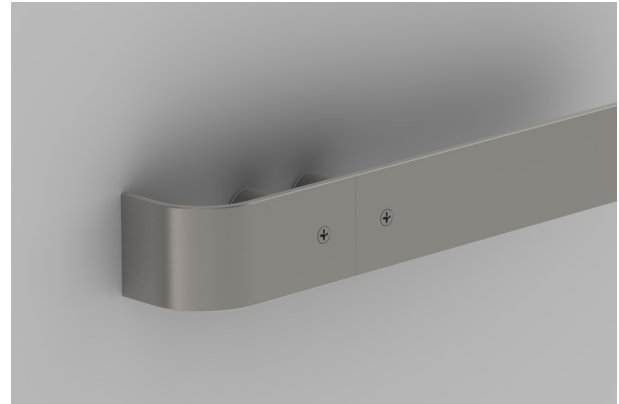

- 3" (76mm) of wall protection, extends 3 1/4" (82mm) from wall
- 1/4" (6.4mm) thick standard Type 304, stainless steel in a No. 4 satin finish
- Manufactured as pre-assembled units per field dimensions
- All mounting fasteners are included with each order

IPC.1959/REV.1

53SS Stainless Steel Wall Guard

Suggested Specifications

PART 1 - GENERAL

1.01 SUMMARY

A. Stainless Steel Wall Guard system for wall protection

1.02 SECTION INCLUDES

A. 53SS Stainless Steel Wall Guard Systems

1.03 SUBMITTALS

A. Product data for each type of wall guard specified.

B. Detail drawings indicating mounting details with the appropriate fasteners for specific project substrates.

C. Samples for verification purposes of wall guard, 6" (152mm) long, in full size profiles of each type indicated.

D. Cleaning and maintenance instructions for door and wall protection systems.

1.04 DELIVERY, STORAGE AND HANDLING

A. Deliver materials in unopened factory packaging to the jobsite and store in original packaging in a climate controlled location away from direct sunlight.

1.05 PROJECT CONDITIONS

A. Products must be installed in an interior climate controlled environment.

1.06 WARRANTY

A. Standard IPC Limited Lifetime Warranty against material and manufacturing defects.

PART 2 - PRODUCTS

2.01 MANUFACTURER

A. Acceptable Manufacturer:
IPC Door and Wall Protection Systems,
InPro Corporation,
PO Box 406 Muskego, WI 53150 USA;
Telephone: 800.222.5556,
Fax: 888.715.8407,
www.inprocorp.com

B. Substitutions: Not permitted

C. Provide all wall guards and wall protection from a single source.

2.02 MANUFACTURED UNITS

A. Wall Guards

1. Stainless Steel Wall Guard
Model Size
53SS, 3" (76mm) h x 3-1/4" (82mm) deep,
Fabricated to field verified dimensions

2. Bracket: 1-1/2" dia x .065 wall thickness, with ABS caps on each end.

2.03 MATERIALS

A. Stainless Steel:

1. Wall Guard shall be manufactured from type 304 Stainless Steel.

2. Wall guard bracket shall be manufactured from type 304 Stainless Steel.

2.04 FINISHES

A. Stainless Steel: #4 satin finish.

PART 3 - EXECUTION

3.01 EXAMINATION

A. Examine areas and conditions in which the wall guard systems will be installed.

1. Complete all finishing operations, including painting, before beginning installation of wall guards.

B. Wall surface shall be dry and free from dirt, grease and loose paint.

3.02 PREPARATION

A. General: Prior to installation, clean substrate to remove dust, debris and loose particles.

3.03 INSTALLATION

A. General: Locate the wall guard as indicated on the approved detail drawing for the appropriate substrate and in compliance with the IPC installation instructions. Install wall guard level and plumb at the height indicated on the drawings.

B. Installation of Stainless Steel Wall Guards:

Note: The 53SS Stainless Steel Wall Guard is manufactured to lengths specified by the customer. When joining sections of wall guard, use a bracket on both sides of the splice.

1. Determine height of wall guard. Using the wall guard as a template, transfer the hole locations to the wall

2. Drill marked holes with 3/4" drill bit for toggle bolts (drywall installation) or 1/2" drill bit for lead anchor (concrete wall installation).

3. Attach the returns and corners to the straight lengths.

4. Loosely attach brackets to the wall guards. Lift the wall guard assembly into position on the wall. Level and tighten fasteners to secure wall guard to wall.

3.04 CLEANING

A. At completion of the installation, clean surfaces in accordance with the IPC clean up and maintenance instructions