

Installation Instructions

Joint System: 616-A07 / A09-600

Note: verify that the structural gap (joint opening) is constructed in conformance with submittal data before beginning installation. In general, this means that (a.) the J.O. is sized properly for the corresponding temperature as shown in the bid documents, (b.) the J.O. is consistent in width along the entire length of the joint and (c.) the J.O. has no abrupt "steps" mandating field correction and action. If this is a fire rated assembly, the fire barrier system must be installed before the architectural joint system. Refer to the fire barrier instructions for specific system installation.

FIG. 1.1 (616-A07-600 WALL TO WALL)

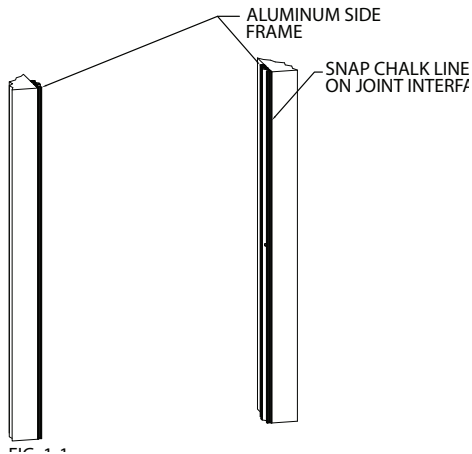

Figure 1

1. Snap a chalk line on the joint interfaces. This will be used later to position the side frames for the entire height of the wall. Installing contractor must fix any irregularities in the substrate walls prior to the installation of the systems.
2. On the ground, assemble 10 foot (3 meter) lengths of the two side bars, three center face seal frames and centering bars.
3. Arrange centering bars so there is one bar between two set screws. Insert set screws from the inside of one side frame. Set screw should not protrude past the outside of the frame. Six centering bars are required for each 10 foot (3 meter) assembly length.

FIG. 1.2

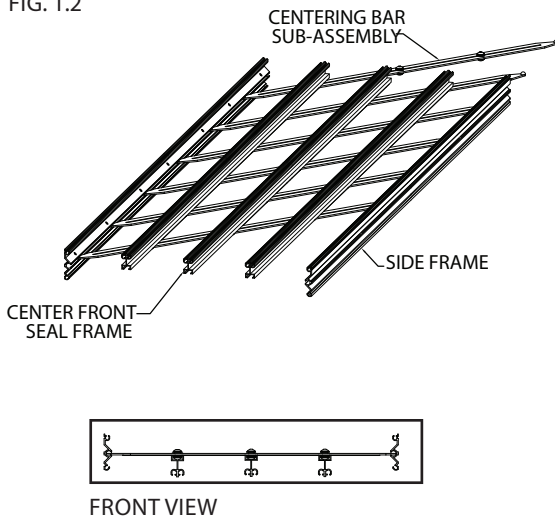
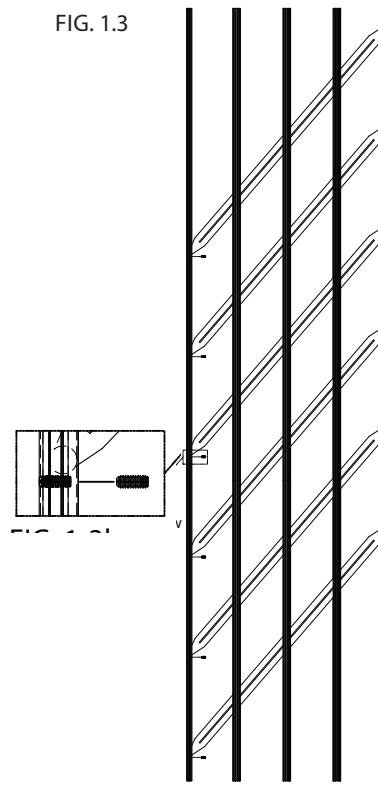

FIG. 1.3



IPC.908/REV.4

Installation Instructions

Joint System: 616-A07 / A09-600

Note: verify that the structural gap (joint opening) is constructed in conformance with submittal data before beginning installation. In general, this means that (a.) the J.O. is sized properly for the corresponding temperature as shown in the bid documents, (b.) the J.O. is consistent in width along the entire length of the joint and (c.) the J.O. has no abrupt “steps” mandating field correction and action. If this is a fire rated assembly, the fire barrier system must be installed before the architectural joint system. Refer to the fire barrier instructions for specific system installation.

FIG. 1.5

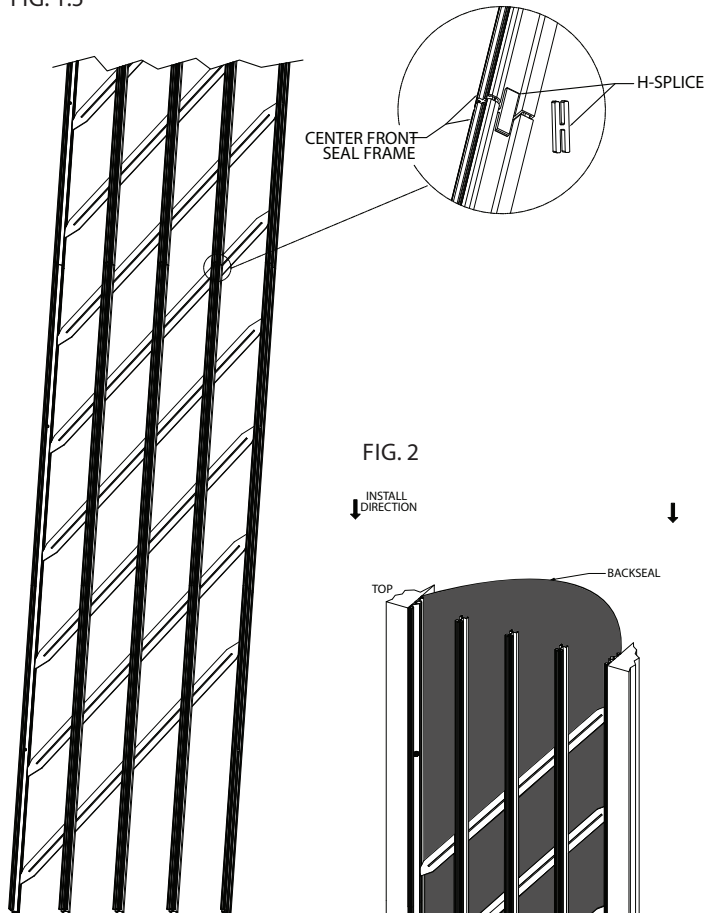

4. Beginning at the base of the wall, expand or contract one 10 foot (3 meter) assembly into the joint opening. Set the side frames in a continuous bead of an appropriate sealant adhesive (as approved by the architect and supplied by the installer) and fasten to the substrate using the hardware as supplied by InPro. Make sure the top ends of the assembly are flush. Angle the centering bars in the frames the same direction so the lower side of the bar rests on the set screw. Slide centering bars until they touch the set screws.
5. For joints exceeding 10 feet in length, repeat steps two through four going up the wall. Attach lengths of the center face seal frames together using H-splices. At the top of the wall, trim lengths as required to adjust to top of wall conditions and/or mate with roof joint products.

FIG. 2

INSTALL DIRECTION ↓

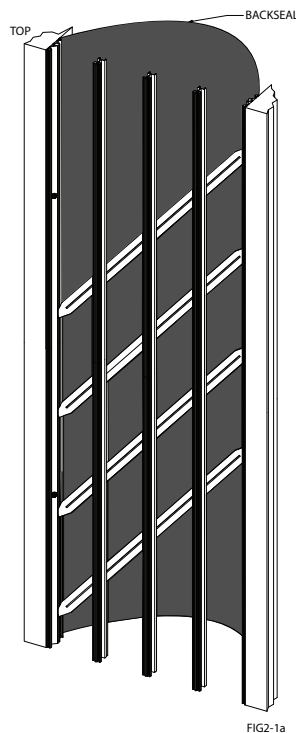
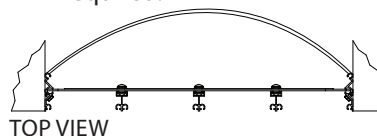

Figure 2

1. Measure the wall height and cut the reinforced vapor barrier to length – making them slightly longer than required. The barrier should be installed in one continuous piece. Apply silicone caulk (supplied by others) on both sides of the wall 2 1/2" (63mm) in from the exterior face. From the top of the wall, unroll the vapor barrier, placing it behind the centering bars. Starting from the top of the wall, sandwich the vapor barrier between the substrate and aluminum frame. The vapor barrier should be installed 1/2" {13mm} in front of the face of the exterior wall.
2. Trim off the excess lengths at the base of the wall.

Note: the back seals should extend to the ground, and be longer than the visual face seals. This will allow any moisture trapped between the seals to escape as required.



Installation Instructions

Joint System: 616-A07 / A09-600

Note: verify that the structural gap (joint opening) is constructed in conformance with submittal data before beginning installation. In general, this means that (a.) the J.O. is sized properly for the corresponding temperature as shown in the bid documents, (b.) the J.O. is consistent in width along the entire length of the joint and (c.) the J.O. has no abrupt “steps” mandating field correction and action. If this is a fire rated assembly, the fire barrier system must be installed before the architectural joint system. Refer to the fire barrier instructions for specific system installation.

FIG. 3

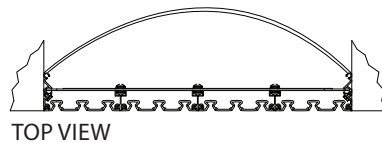
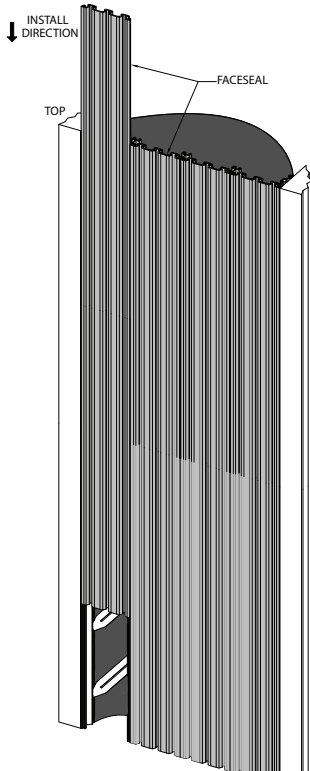

Figure 3

1. Cut the four face seals to length – making them slightly longer than required. The seals should be installed in one continuous piece. From the top of the wall, unroll the four lengths, placing the seal lengths on the front side of the centering bars. Starting from the top of the wall, insert the four seal lengths pushing the lugs into the frame receptacles. Fantastic or soapy water solution will help with the insertion.
2. Trim off the excess lengths at the base of the wall.
Note: the face seals should be 1" shorter than the back seals. This will allow any moisture trapped between the seals to escape as required.
3. Depending upon the project requirements, a continuous bead of caulk may be required to be installed where the outside edges of the face seals abut the substrate walls. This caulk is supplied by others.

Figure 4

1. Per project dictates, address details at the top of the wall where the system meets with the expansion joint on the roof or roof parapet. This transition area, and components, should be shown in InPro Shop Drawing details. If none are shown, please contact InPro for appropriate details.

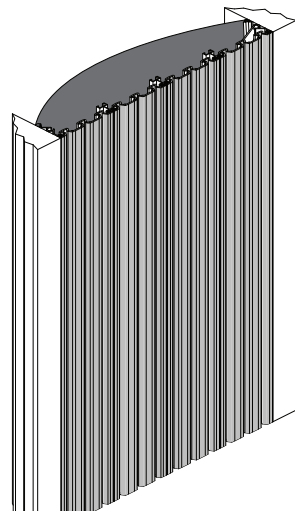

FIG. 4 (616-A07-600 WALL TO WALL)