

733 Series

A01 - Floor to Floor

A02 - Floor to Wall

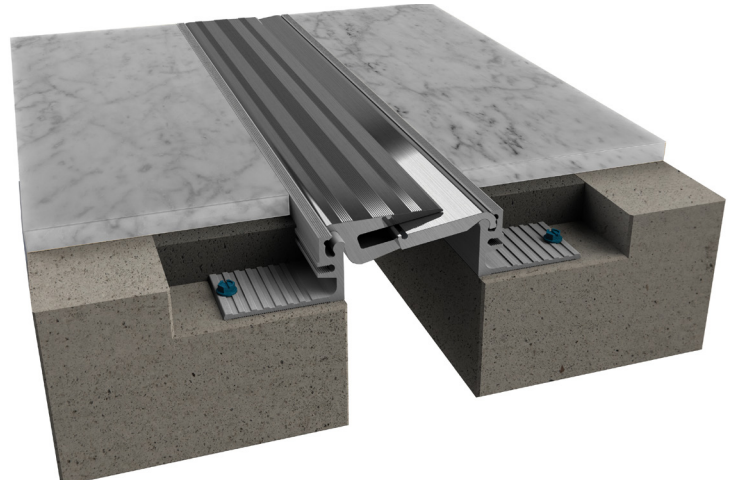

Movement: 25%

Product Guide



Thermal



Interior



Heavy
Duty



ADA
Compliant

- ▶ Ideal for high frequency pedestrian traffic and frequent heavy rolling loads commonly encountered in airports, convention centers, subways and hospitals projects.
- ▶ Applies to joints of 1" - 4" [25mm - 100mm]
- ▶ Narrow sightline minimizes impact to interior aesthetics of space.
- ▶ Recessed & Surface mount options allow for use in new and retrofit projects.
(Ref: 734 series for surface mount)
- ▶ Serrated surface provides excellent slip resistance.
- ▶ Integral microseal eliminates noise while blocks debris and liquids from entering mechanism.
- ▶ Exceptional $\pm 25\%$ thermal movement.

Application	System	W		H		H1		S		B		Movement +/-			
		Joint Width		Frame Height		Frame Height		Sightline		Blockout		Horizontal		Vertical	
		US	mm	US	mm	US	mm	US	mm	US	mm	US	mm	US	mm
Floor to Floor	733-A01-025	1"	25	1 1/2"	35	*	*	2"	50	3"	75	3/16"	5	3/16"	5
	733-A01-050	2"	50	1 1/2"	35	*	*	3"	75	3"	75	1/2"	12	1/2"	12
	733-A01-075	3"	75	1 1/2"	35	*	*	4"	102	3"	75	3/4"	20	3/4"	20
	733-A01-100	4"	102	1 1/2"	35	*	*	5"	126	3"	75	1"	25	1"	25
Floor to Wall	733-A02-025	1"	25	1 1/2"	35	1 1/2"	35	2"	51	3 1/2"	89	3/16"	5	3/16"	5
	733-A02-050	2"	50	1 1/2"	35	1 1/2"	35	3"	77	3 1/2"	89	1/2"	12	1/2"	12
	733-A02-075	3"	75	1 1/2"	35	1 1/2"	35	4"	102	3 1/2"	89	3/4"	20	3/4"	20
	733-A02-100	4"	102	1 1/2"	35	1 1/2"	35	5"	127	3 1/2"	89	1"	25	1"	25

IPC.3048/REV.2

733 Series

Heavy Duty Slide Plate Systems

J733-A01-075 Floor/Floor
(3" (75mm) system shown)

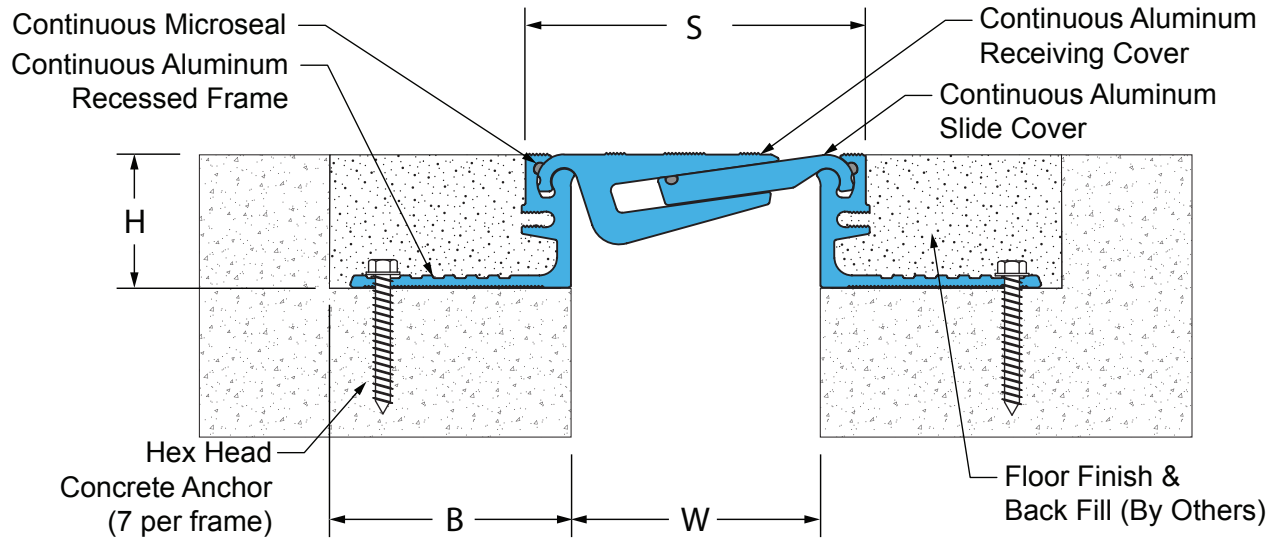

J733-A02-075 Floor/Wall
(3" (75mm) system shown)

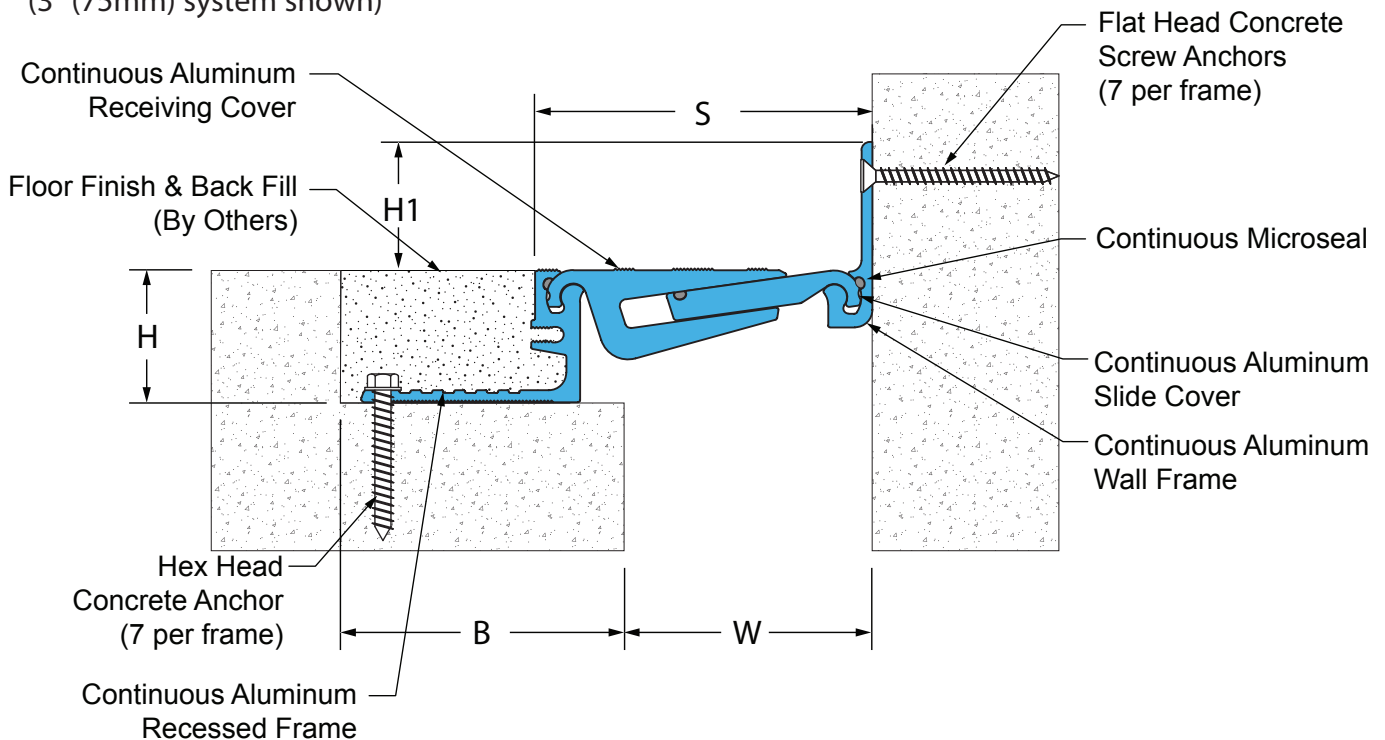

733 Series

Heavy Duty Slide Plate Systems

J733-A01-050 Floor/Floor
(Vapor Barrier Shown)

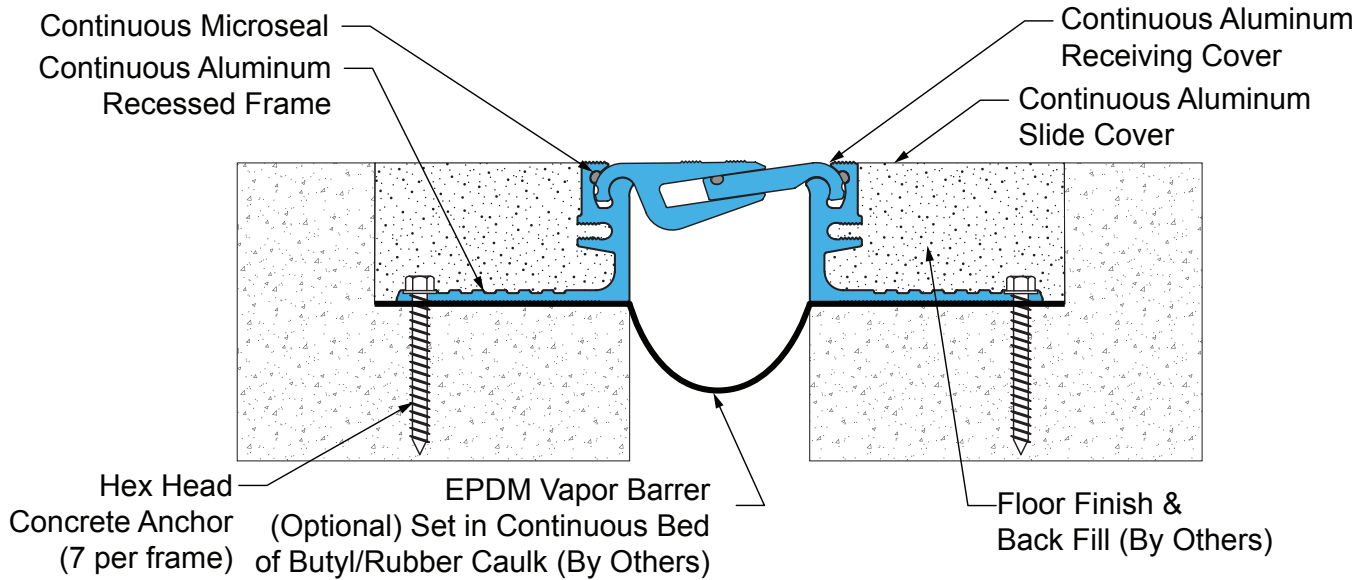

J733-A01-050 Floor/Floor
(Fire Barrier Shown)

