

787 Series

A01 - Floor to Floor

A02 - Floor to Wall

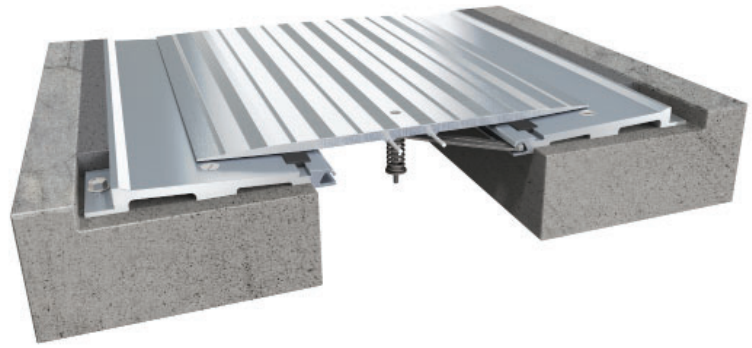

Movement Rating ± 50%

Product Guide



Seismic

Exterior

Interior

Heavy Duty

Fire Rated Option

Vapor Barrier Option

- ▶ Seismic capable system designed to meet the needs of Open Structures and Vehicular loading.
- ▶ Industry unique profile drastically reduces the lateral impact (shear forces) encountered with repeated vehicular traffic. This maximizes product lifespan & ensures against the premature fatigue encountered in other configurations on the market.
- ▶ Tapered plate and frames provide a seamless, ADA compliant design that constantly levels itself and maintains a flush condition.
- ▶ Heavy duty design uses a thick high strength centering bar and spring assembly, to resist vibrations.
- ▶ 1" [25mm] frame depth ensures no interference in rebar / cabling structure.
- ▶ Serrated cover plate for added slip resistance.
- ▶ Integral high durometer seal deters water from entering the system and acts as a noise dampening device.
- ▶ Reinforced Vapor Barrier is included.
- ▶ System designed for areas of low speed traffic (5-10 mph)

Application	System	W		H		S		B		Movement +/-			
		Joint Width		Frame Height		Sightline		Blockout		Horizontal		Vertical	
		US	mm	US	mm	US	mm	US	mm	US	mm	US	mm
Floor to Floor	787-A01-100	4"	100	1"	25	13 1/2"	342	6"	152	2"	51	1"	25
	787-A01-150	6"	150	1"	25	16 1/2"	419	6 1/2"	165	3"	76	1 1/2"	38
	787-A01-200	8"	200	1"	25	18 1/2"	470	6 1/2"	165	4"	102	2"	51
	787-A01-250	10"	250	1"	25	24 1/2"	622	8 1/2"	216	5"	127	2 1/2"	64
	787-A01-300	12"	300	1"	25	26 1/2"	673	8 1/2"	216	6"	152	3"	76
Floor to Wall	787-A02-100	4"	100	1"	25	8 3/4"	222	6"	152	1"	25	1"	25
	787-A02-150	6"	150	1"	25	11 1/4"	286	6 1/2"	165	1 1/2"	76	1 1/2"	38
	787-A02-200	8"	200	1"	25	13 1/4"	337	6 1/2"	165	2"	102	2"	51
	787-A02-250	10"	250	1"	25	17 1/4"	438	8 1/2"	216	2 1/2"	127	2 1/2"	64
	787-A02-300	12"	300	1"	25	19 1/4"	489	8 1/2"	216	3"	152	3"	76

*Contact your InPro Representative for project specific loading capabilities.

IPC.1564/REV.8

787 Series

Heavy Duty Seismic Floor Systems

787-A01 Floor/Floor
(4" (100mm) system shown)

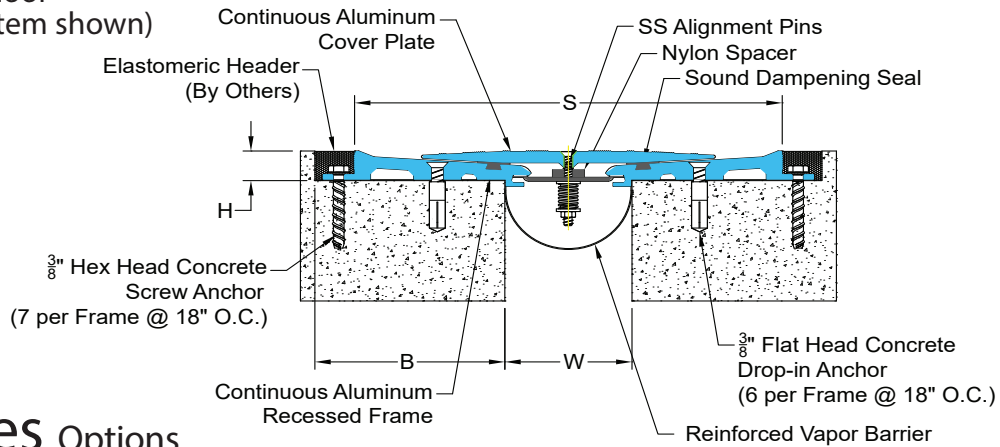

787 Series Options

787-A01 Floor/Floor With Fire Barrier
(4" (100mm) system shown)

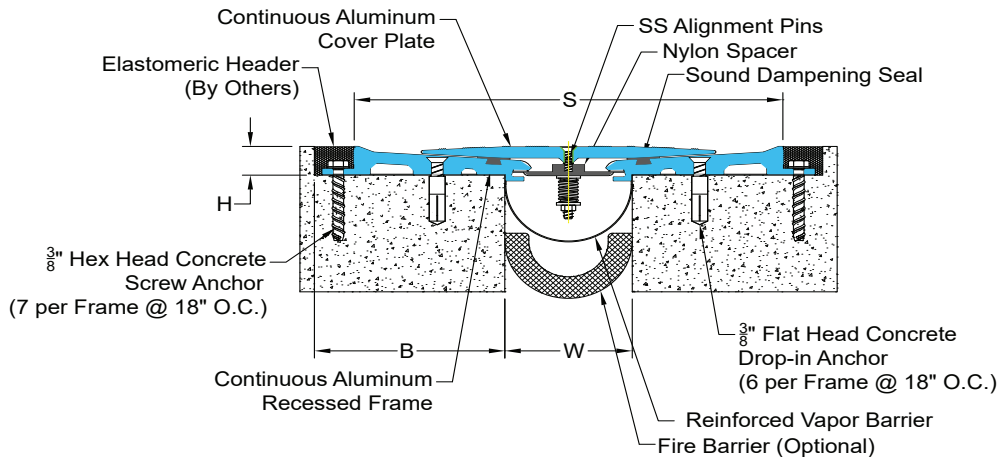

787-A01 Floor/Floor With Vapor Barrier
(4" (100mm) system shown)

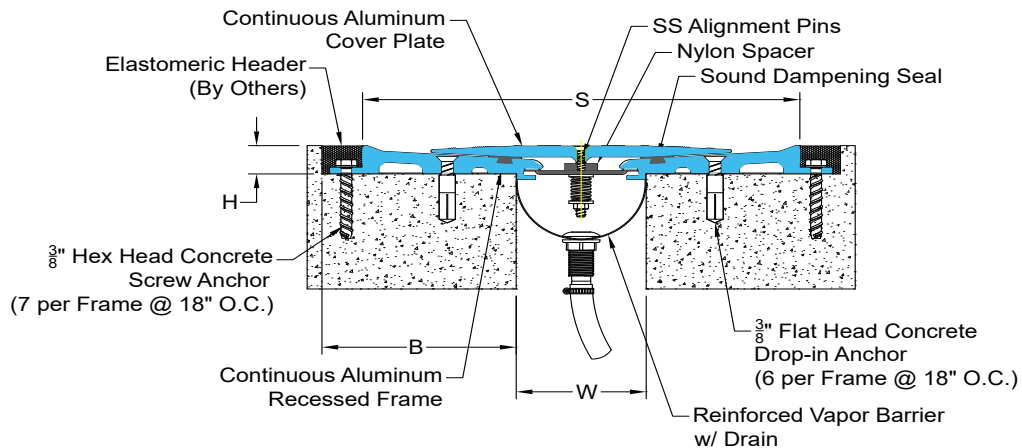

787 Series

Heavy Duty Seismic Floor Systems

787-A02 Floor/Wall (4" (100mm) system shown)

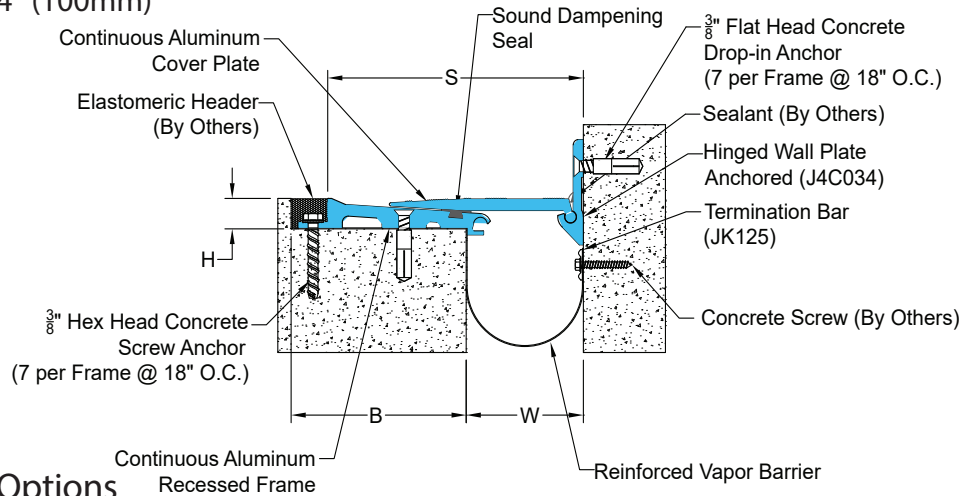

787 Series Options

787-A02 Floor/Wall With Fire Barrier (4" (100mm) system shown)

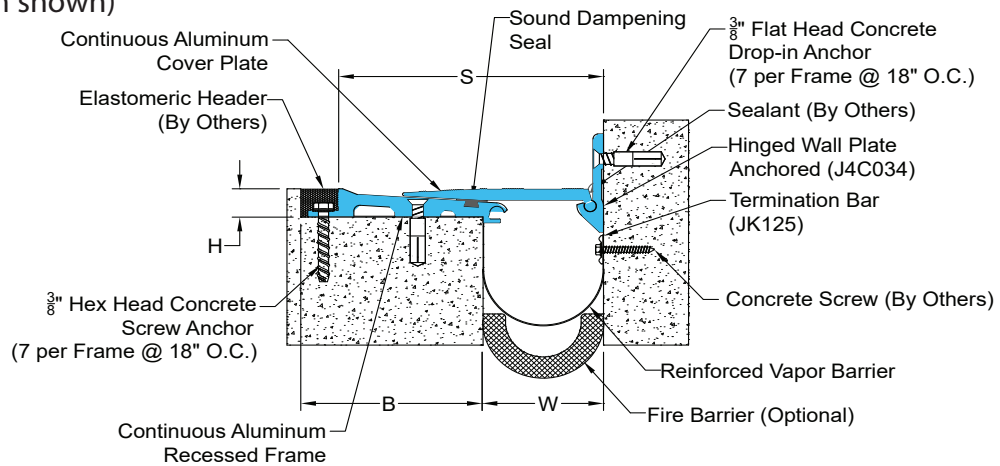

787-A02 Floor/Wall With Vapor Barrier (4" (100mm) system shown)

